



Sense 4000lm Driver Kit DALI



900mA, CC (Constant current), 220-240V, 50/60Hz, SELV

Sense Driver Kit:

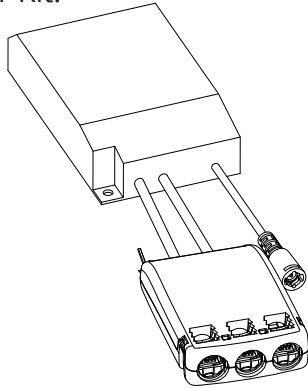

Sense Panel:

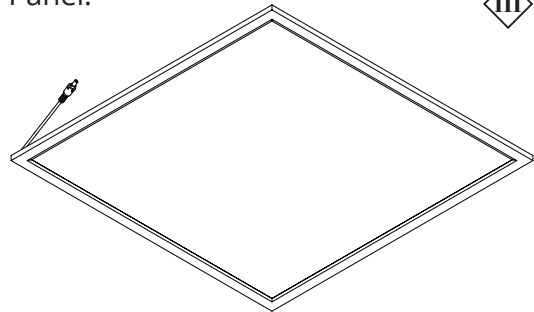

(Sold separately)

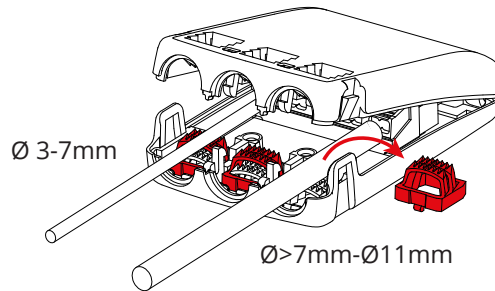
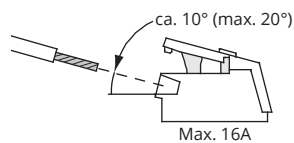
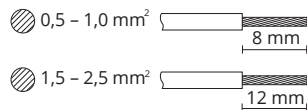

Push Dim

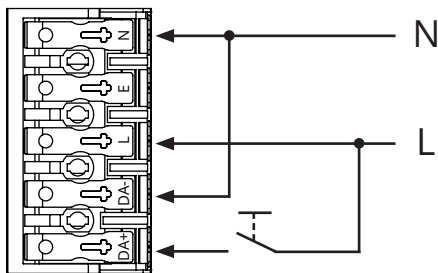

DALI Dim

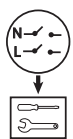
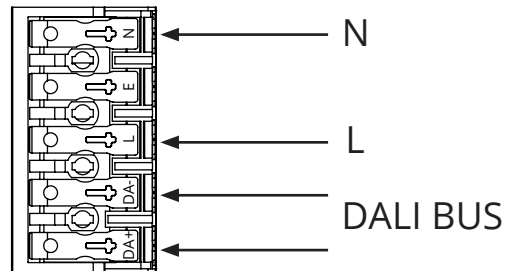

NO: Skru av strømmen før montering.
DK: Sluk for strømmen inden montering.
SE: Stäng av strømmen innan montering.
EN: Turn off power before installing.
FR: Couper le courant avant l'installation.
NL: Stroom uitschakelen voor u het toestel installeert.
DE: Vor Installationsarbeiten den Strom abschalten.
FI: Sammuta virta ennen kytkemistä

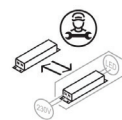

NO: Kan kun installeres og vedlikeholdes av en registrert installasjonsvirksomhet.
DK: Må kun installeres og vedlikeholdes af uddannet elektriker.
SE: Skall installeras och underhållas av behörig elektriker.
EN: Only to be installed and maintained by an authorized electrician.
FR: Doit être installé et maintenu par un électricien qualifié.
NL: Mag alleen geïnstalleerd en onderhouden worden door een bevoegde electricien.
DE: Dieses Produkt darf nur durch autorisiertes Personal (z.B. Elektro-Installateur) angeschlossen, in Betrieb genommen und gewartet werden.
FI: Asentaa ja huoltaa saa vain valtuutettu sähköasentaja

Rev: 28.01.2021

NORWAY
 SG Armaturen AS
 Skytterheia 25
 N-4790 Lillesand

SWEDEN
 SG Armaturen AB
 Tel: +46 31 81 71 10
 info@sg-ab.se
 www.sg-ab.se

DENMARK
 SG Armaturen A/S
 Tel: +45 70 70 72 13
 info@sg-as.dk
 www.sg-as.dk

FRANCE
 SG Lighting SA/NV
 Tel: +33(0) 4 94 93 00 00
 info.france@sglighting.fr
 www.sglighting.net

GERMANY
 SG Leuchten GmbH
 Tel: +49 40 23 99 44 59
 info@sg-leuchten.de
 www.sg-leuchten.de

Tel: +47 37 50 03 00
 firmapost@sg-as.no
 www.sg-as.no

FINLAND
 SG Armaturen Oy
 Tel: +358 02 07 30 39 60
 info@sg-oy.fi
 www.sg-oy.fi

UNITED KINGDOM
 SG Lighting LTD
 Tel: +47 37 50 03 00
 info@sglighting.co.uk
 www.sglighting.co.uk

BENELUX
 SG Lighting SA/NV
 Tel: +32(0) 15 20 72 71
 info.benelux@sglighting.net
 www.sglighting.net

INTERNATIONAL
 SG Lighting Co Ltd.
 Tel: +86 769 88 49 20 88
 cindy@sgdgc.com
 www.sg-as.com

Dipswitch

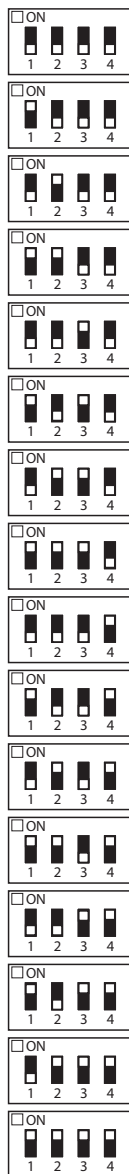

mA	lm
300	33%
350	39%
400	44%
450	50%
500	56%
550	61%
600	67%
650	72%
700	78%
750	83%
800	89%
850	94%
900	100%
950	106%
1000	111%
1050	117%

Standard

